

4 x FHD(8MP) iA H.265 Multi-Sensor Camera

Panasonic WV-S8530N captures the highest quality images in even very challenging and dynamic environments.

In particular, the camera can capture clear vehicle image in color even at night intersections of low light intensity.

And the four repositionable lenses minimize blind spots and flexibly correspond to intersections of various shapes and monitoring areas of cities.

Intelligent Auto (iA) monitors scene dynamics and motion to adjust key camera settings automatically in real-time reducing distortion such as motion blur on moving objects. Adopting H.265 Smart Coding technology, bandwidth efficiency is intelligently increased for longer recording and less storage. Out of the box, the camera supports full data encryption streaming and is compliant to FIPS 140-2 Level 1 standards to keep your video secured.

Extreme image quality for evidence capturing under challenging conditions

- Four repositionable lenses with easy adjustment include a wide range tilt angle mechanism minimizes blind spots
- Sharp and clear images of fast moving vehicles with Intelligent Auto and ClearSight Coating
- Outstanding low light performance in true color with low noise for night time applications
- Super Dynamic 108dB for backlit situations and shadows on night streets
- Environmental durability : IP66, IK10 and Dehumidification device

Extreme H.265 compression with new Smart Coding

- Reduced the amount of transferred data and less storage space compared to any H.264 based compression techniques
- New self-learning ROI* encoding (Auto VIQS) dynamically detect motion areas to keep vehicles and human in good picture quality while lowering your bandwidth *Region of Interest

Extreme Data Security

- Full encryption SD card edge recording to keep your data safe
- FIPS 140-2 Level 1 compliant
- Full end-to-end system encryption with supported VMS and devices to protect from IP snooping/spoofing and detect data alteration

Key Features

- 4 x FHD(8MP) 1600x1200 / 1920x1080 30fps
- iA (intelligent Auto)
- Super Dynamic 108dB
- Color night vision (0.006 to 0.09 lx)
- H.265 Smart Coding
- ClearSight Coating
- Wide range tilt angle adjustment mechanism

Industry examples

- Public safety (City / Highway toll / Parking gate)
- Transportation (Airport / Train / Subway)



Wide range tilt angle adjustment mechanism

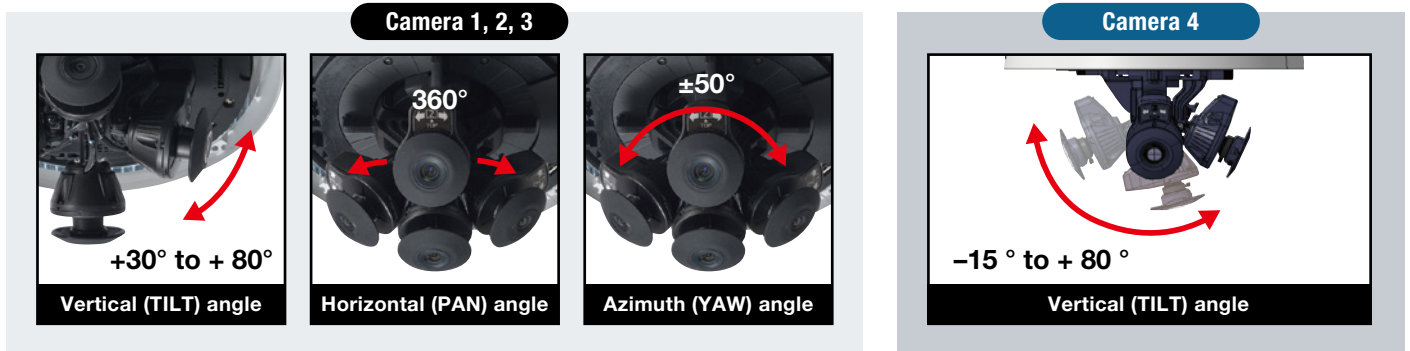

*The above is the adjustable range of a single camera. The adjustable range of each camera varies according to the positional relationship with other cameras.

Four repositionable lenses enables to monitoring at minimize blind spots

270-degree view (Full intersection view)

- One multi sensor camera at intersection corner, It enables monitoring with minimized blind spots
- Enables to monitoring even if bottom view angle

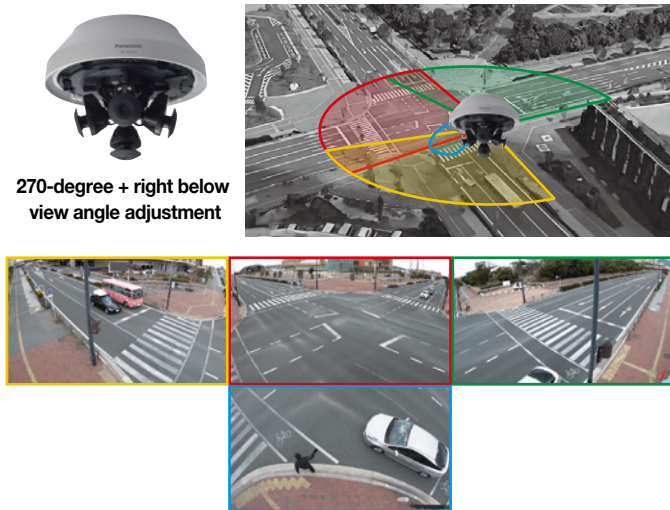

360-degree view

- One multi-sensor camera enables monitor the park by minimize blind spots



Usability - Easy setting

- Installation time can be reduced by confirming live image and adjusting viewing angle with smartphone or tablet device via Wi-Fi connection.

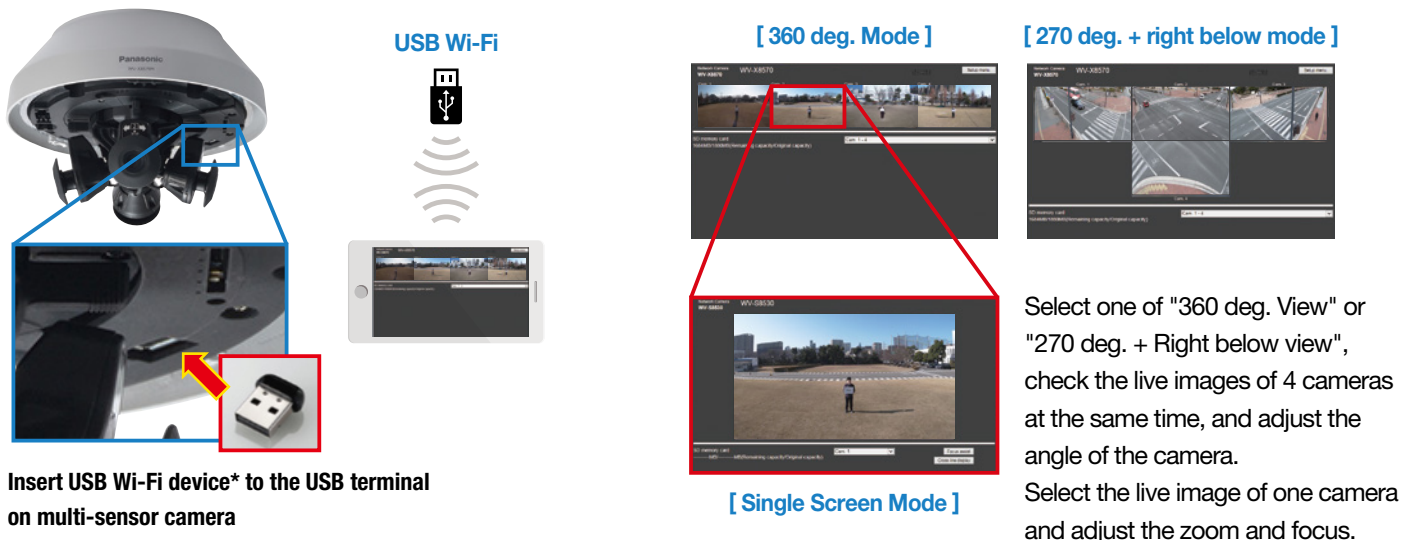

Specifications

Camera	Image Sensor	1/3 type CMOS image sensor
	Minimum Illumination	Color : 0.09 lx, BW : 0.04 lx (F2.2, Maximum shutter : Off (1/30s), AGC : 11) Color : 0.006 lx, BW : 0.003 lx (F2.2, Maximum shutter : max. 16/30s, AGC : 11) ^{*1}
	Intelligent Auto	On / Off
	Maximum shutter	Max.1/10000s to Max.16/30s
	Super Dynamic	On / Off, the level can be set in the range of 0 to 31.
	Dynamic Range	108 dB typ. (Super Dynamic : On, level : 31)
	Image Settings	Gain (AGC), White balance
	Image Compensation	Adaptive black stretch, Back light compensation (BLC), High light compensation (HLC), Fog compensation, Digital noise reduction
	Color/BW (ICR)	Off / On / Auto1 (Normal) / Auto2 (IR Light) / Auto3 (SCC)
	Video Motion Detection (VMD)	On / Off, 4 areas available
	Privacy Zone	On / Off (up to 8 zones available)
	Upside-down	On / Off
	Camera Title (OSD)	On / Off Up to 20 characters (alphanumeric characters, marks)
	Adjusting angle	Camera 1, 2, 3 : Horizontal (PAN) angle : 360 ° Vertical (TILT) angle : +30 ° to + 80 ° Azimuth (YAW) angle : ±50 ° Camera 4 : Horizontal (PAN) angle : 360 ° Vertical (TILT) angle : -15 ° to + 80 ° Azimuth (YAW) angle : ±50 ° *The above is the adjustable range of a single camera. The adjustable range of each camera varies according to the positional relationship with other cameras.
	Lens	Zoom Ratio
Digital (electronic) zoom		Choose from 3 levels of x1, x2, x4
Focal length		3.2 mm - 5.7 mm (1/8 inches - 7/32 inches)
Maximum Aperture Ratio		1 : 2.2 (WIDE) - 1 : 3.1 (TELE)
Focus range		1.5 m (4.92 feet) - ∞
Angular Field of view with one lens		[16 : 9] Horizontal : 53 ° (TELE) - 99 ° (WIDE) Vertical : 30 ° (TELE) - 54 ° (WIDE) [4 : 3] Horizontal : 44 ° (TELE) - 81 ° (WIDE) Vertical : 33 ° (TELE) - 60 ° (WIDE)
Browser GUI		Camera Control : Brightness GUI / Setup Menu Language : English, Italian, French, German, Spanish, Portuguese, Russian, Chinese, Japanese
Network		Network IF
	Resolution with one lens	[16 : 9 mode] 1920 x 1080 / 1280 x 720 / 640 x 360 / 320 x 180 [4 : 3 mode] 1600 x 1200 / 1280 x 960 / 640 x 480 / 320 x 240
	H.265/ H.264 ² Transmission Mode	Constant bit rate / VBR / Frame rate / Best effort
	Transmission Type	Unicast / Multicast
	JPEG Image Quality	10 steps
	Smart Coding	GOP (Group of pictures) control : On (Frame rate control) / On (Advanced) / On (Low) / On (Mid) / Off *On (Frame rate control) and On (Advanced) are only available with H.265. Auto VIQS : On / Off
	Supported Protocol	IPv6 : TCP/IP, UDP/IP, HTTP, HTTPS, FTP (Server), SMTP, DNS, NTP, SNMP, DHCPv6, RTP, MLD, ICMP, ARP, IEEE 802.1X, DiffServ IPv4 : TCP/IP, UDP/IP, HTTP, HTTPS, RTSP, RTP, RTP/RTCP, FTP (Server), SMTP, DHCP, DNS, DDNS, NTP, SNMP, UPnP, IGMP, ICMP, ARP, IEEE 802.1X, DiffServ



Network	Maximum concurrent access number	Up to 24 users (Depends on network conditions)
	SDXC/SDHC/SD Memory Card	H.265 / H.264 recording : Manual REC / Alarm REC (Pre/Post) / Schedule REC / Backup upon network failure Compatible SDXC/SDHC/SD card : Panasonic 2 GB, 4 GB*, 8 GB*, 16 GB*, 32 GB*, 64 GB**, 128 GB**, 256 GB**model *SDHC card, ** SDXC card (except miniSD card and microSD card)
	Mobile Terminal Compatibility	iPad / iPhone, Android™ mobile terminals
Alarm	Alarm Source	VMD alarm, Command alarm
	Alarm Actions	SDXC/SDHC/SD memory recording, E-mail notification, HTTP alarm notification, Indication on browser, Panasonic alarm protocol output
General	Safety	UL (UL60950-1), c-UL (CSA C22.2 No.60950-1), CE, IEC60950-1
	EMC	FCC (Part15 ClassA), ICES003 ClassA, EN55032 ClassB, EN55024
	Power Source and Power Consumption	PoE (IEEE802.3af compliant) Device : DC 48 V 210 mA/Approx. 10.1 W (Class 0 device)
	Ambient Operating Temperature	-40 °C to +60 °C (-40 °F to +140 °F)
	Temperature	{Power On range : -20 °C to +60 °C (-4 °F to +140 °F)}
	Ambient Operating Humidity	10 to 100 % (no condensation)
	Water and Dust Resistance	IP66 (IEC60529), Type 4X (UL50), NEMA 4X compliant
	Shock Resistance	IK10 (IEC62262)
	Dimensions	When using the attachment plate only : ø230 mm x 196 mm (H) {ø9-1/16 inches x 7-23/32 inches (H)}, Dome radius 80 mm (3-5/32 inches) When using the base bracket : ø230 mm x 232 mm (H) {ø9-1/16 inches x 9-1/8 inches (H)}, Dome radius 80 mm (3-5/32 inches)
	Mass (approx.)	When using the attachment plate only : Approx. 2.7 kg (5.95 lbs) When using the base bracket : Approx. 3.2 kg (7.05 lbs)
Finish	Main body : Aluminum die cast, Light gray, Outer fixing screws : Stainless steel (Corrosion-resistant treatment) Dome cover : Polycarbonate resin (with ClearSight coating), Clear	

*1 Converted value
*2 H.265/H.264 can be selected for each stream.

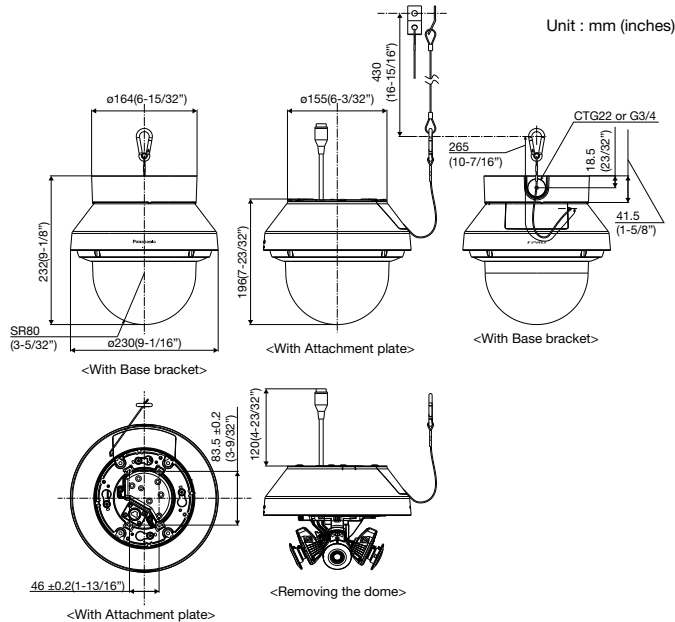
Appearance



Optional Accessories

Wall Mount Bracket WV-Q185 (Light gray) WV-Q122A (Fine silver) (Use with the WV-Q187.)		Mount Bracket WV-Q187 (Light gray)  (These brackets are used with WV-Q185 or WV-Q122A.)
Pole Mount Bracket WV-Q182 (Light gray) WV-Q188 (Fine silver) (These brackets are used with WV-Q185 or WV-Q122A.)		Corner Mount Bracket WV-Q183 (Light gray) WV-Q189 (Fine silver) (These brackets are used with WV-Q185 or WV-Q122A.)

• The brackets are available in two colors, Light gray and Fine silver.
It is possible to use them in the different color combination.

Trademarks and registered trademarks

- iPad and iPhone are trademarks of Apple Inc., registered in the U.S. and other countries.
- Android is a trademark of Google LLC.
- ONVIF and the ONVIF logo are trademarks or registered trademarks of Onvif Inc.
- All other trademarks identified herein are the property of their respective owners.

Important

- Safety Precaution : Carefully read the Important Information, Installation Guide and operating instructions before using this product.
- Panasonic cannot be responsible for the performance of the network and/or other manufacturers' products used on the network.

• Masses and dimensions are approximate. • Specifications are subject to change without notice.

DISTRIBUTED BY :

Panasonic

<https://security.panasonic.com>

 <https://www.facebook.com/PanasonicNetworkCamera>

(2A-207BA)