

New U-series compact network camera with enhanced functions and affordability

## Full HD Indoor Dome Network Camera

The new U series is an entry model that achieves high quality and reliability at an affordable price to meet the needs of a wide range of customers. The compact and slim design allows it to be installed in a various locations.

It newly supports ONVIF G / S / T profile and H.265 / H.264, and can be widely used for connecting various VMS and recorders. It also comes pre-installed with secure certificates, enabling device authentication and end-to-end communication encryption to counter the threat of advanced cyberattacks.

### Key features

- Compact and slim design allows installation in various locations
- Compliant with ONVIF G / S / T profile and H.265 / H.264, and can support a wide range of connections to VMS and recorders
- Uses "Easy Kitting Packing" that allows you to set the camera without removing it from the box
- Strengthen cyber security by pre-installing digital certificates issued by a third party organization (GlobalSign)

### Key i-PRO Spec.

- Full HD 1080p up to 30fps
- iA (intelligent Auto)
- Super Dynamic 120dB
- Color night vision (0.006 to 0.1 lx)
- H.265 Smart Coding
- Corridor mode  
(90 degrees or 270 degrees in image rotation)
- Built-in IR LED
- ONVIF Profile G / S / T

### Industry examples

- Retail
- Education
- Public safety
- Bank / Hospital / Building



•••PRO

## Specifications

<b>Camera</b>	Image Sensor	Approx. 1/3 type CMOS image sensor
	Minimum Illumination	Color : 0.1 lx, BW : 0.04 lx (50IRE, F2.0, Maximum shutter : Off (1/30s), AGC : 11) BW : 0 lx (50IRE, F2.0, Maximum shutter : Off (1/30 s), AGC : 11, when the IR LED is lit) Color : 0.006 lx, BW : 0.0025 lx (50IRE, F2.0, Maximum shutter : max. 16/30s, AGC : 11) *1
	White Balance	ATW1/ ATW2/ AWC
	Maximum shutter	<b>[30fps mode]</b> Max. 1/10000 s to Max. 16/30 s <b>[25fps mode]</b> Max. 1/10000 s to Max. 16/25 s
	Intelligent Auto	On / Off
	Super Dynamic	On / Off, The level can be set in the range of 0 to 31.
	Dynamic Range	Max. 120 dB (Super Dynamic : On, Level: 31)
	Adaptive Black Stretch	The level can be set in the range of 0 to 255.
	Back light compensation / High light compensation	BLC (Back light compensation) / HLC (High light compensation) / Off The level can be set in the range of 0 to 31. (only when Super dynamic / Intelligent Auto : Off)
	Fog compensation	On / Off, The level can be set in the range of 0 to 8. (only when intelligent auto / auto contrast adjust: Off)
	Maximum gain (AGC)	The level can be set in the range of 0 to 11.
	Color/BW (ICR)	Off / On (IR Light Off) / On (IR Light On) / Auto1 (IR Light Off) / Auto2 (IR Light On) / Auto3 (SCC)
	IR LED Light	High / Middle / Low / Off, Maximum irradiation distance : 30 m (Approx. 100 ft)
	Digital Noise Reduction	The level can be set in the range of 0 to 255.
	Video Motion Detection (VMD)	On / Off, 4 areas available
	Scene Change Detection (SCD)	On / Off, 1 area available
	Privacy Zone	On / Off, Up to 8 zones available
	VIQS	On / Off, Up to 8 zones available
	Image rotation <sup>*2</sup>	0° (Off) / 90° / 180° (Upside-down) / 270°
	Camera Title (OSD)	On / Off, Up to 20 characters (alphanumeric characters, marks)
<b>Lens</b>	Focal length	3.2 mm (1/8 inches)
	Optical zoom	1x
	Extra zoom	1.0x - 1.5x (when resolution is 1280x720)
	Digital (electronic) zoom	Choose from 3 levels of x1, x2, x4
	Angular Field of View	<b>[16 : 9 mode]</b> Horizontal : 100° Vertical : 54° <b>[ 4 : 3 mode]</b> Horizontal : 81° Vertical : 60°
	Maximum Aperture Ratio	1 : 2.0
Focusing Range	1 m {39-3/8 inches} - ∞	
<b>DORI</b>	Detect (25ppm / 8ppf)	37.5 m / 122.9 ft
	Observe (62.5ppm / 19ppf)	15.0 m / 49.2 ft
	Recognize (125ppm / 38ppf)	7.5 m / 24.6 ft
	Identify (250ppm / 76ppf)	3.7 m / 12.3 ft
<b>Adjusting Angle</b>	Horizontal (PAN) angle: -175° - +175°, Vertical (TILT) angle: -30° - +80° Azimuth (YAW) angle: ±100°	
<b>Browser GUI</b>	Camera Control	Brightness
	GUI / Setup Menu Language	English, Italian, French, German, Spanish, Portuguese, Russian, Chinese, Japanese

<b>Network</b>	Network IF	10Base-T / 100Base-TX, RJ45 connector						
	Resolution	<b>[16 : 9 mode]</b> 1920×1080, 1280×720, 640×360, 320×180 <b>[ 4 : 3 mode]</b> 1600×1200, 1280×960, VGA, QVGA						
	H.265/ H.264	Transmission Mode Constant bit rate / VBR / Frame rate / Best effort						
	H.264	Transmission Type	Unicast port(AUTO) / Unicast port(MANUAL) / Multicast					
			Max. frame rate for each stream <sup>*3</sup>	<b>Stream(1)</b>	<b>Stream(2)</b>	<b>Stream(3)</b>	<b>JPEG(1)</b>	<b>JPEG(2)</b>
				1920x1080(30fps)	640x360(30fps)	Off	1920x1080(1fps)	1280x720(1fps)
				1280x720(30fps)	1280x720(30fps)	Off	1920x1080(1fps)	1280x720(1fps)
	1600x1200(30fps)	640x480(30fps)	Off	1600x1200(1fps)	1280x960(1fps)			
	JPEG	Image Quality	10 steps					
	Smart Coding	<b>GOP(Group of pictures) control:</b> On(Frame rate control) / On(Advanced) / On(Mid.) / On(Low) / Off *Frame rate control and Advanced are only available with H.265. <b>AUTO VIQS:</b> On / Off						
	Audio Compression	—						
	Audio transmission mode	—						
	Supported Protocol	IPv6 : TCP/IP, UDP/IP, HTTP, HTTPS, SSL/TLS, SMTP, DNS, NTP, SNMPv1/v2/v3, DHCPv6, RTP, MLD, ICMP, ARP, IEEE 802.1X, DiffServ IPv4 : TCP/IP, UDP/IP, HTTP, HTTPS, SSL/TLS, RTSP, RTP, RTP/RTCP, SMTP, DHCP, DNS, DDNS, NTP, SNMPv1/v2/v3, UPnP, IGMP, ICMP, ARP, IEEE 802.1X, DiffServ						
	No. of Simultaneous Users	Up to 14 users (Depends on network conditions)						
	SDXC/SDHC/SD Memory Card (Option)	H.265/H.264 recording: Manual REC / Alarm REC (Pre/Post) / Schedule REC Available SDXC/SDHC/SD Memory Card : microSDXC memory card: 64 GB, 128 GB, 256 GB, 512 GB microSDHC memory card: 4 GB, 8 GB, 16 GB, 32 GB microSD memory card: 2 GB						
Mobile Terminal Compatibility	iPad, iPhone, Android™ terminals							
ONVIF Profile	G / S / T							
<b>Alarm</b>	Alarm Source	VMD alarm, SCD alarm, Command alarm						
	Alarm Actions	SDXC/SDHC/SD memory recording, E-mail notification, HTTP alarm notification, Indication on browser, Panasonic alarm protocol output						
<b>Input/ Output</b>	Monitor Output (for adjustment)	—						
	Audio input	—						
	Audio Output	—						
	External I/O Terminals	—						
<b>General</b>	Safety	UL (UL60950-1), c-UL (CSA C22.2 No.60950-1), CE, IEC60950-1						
	EMC	FCC (Part15 ClassA), ICES003 ClassA, EN55032 ClassB, EN55024						
	Power Source and Power Consumption	PoE (IEEE802.3af compliant) Device : DC48 V 100 mA, Approx. 4.8 W (Class 2 device)						
	Ambient Operating Temperature	-10 °C to +50 °C (+14 °F to +122 °F) {Power On range: 0 °C to +50 °C (+32°F to +122 °F)}						
	Ambient Operating Humidity	10 to 90 % (no condensation)						
	Dimensions	ø109 mm x 62 mm (H) {ø4-9/32 inches x 2-7/16 inches (H)} Dome radius 30.5 mm (1-3/16 inches)						
	Mass (approx.)	250 g {0.55 lbs}						
	Finish	Main body : Aluminum die cast / Polycarbonate resin, i-PRO white Dome section : Polycarbonate resin, Clear						

\*1 Converted value

\*2 When "4:3(30fps mode)" or "4:3(25fps mode)" is selected for "Image capture mode", "90 °" and "270 °" cannot be selected.

\*3 Smart Coding(GOP and AUTO VIQS) is not available when setting 30fps.





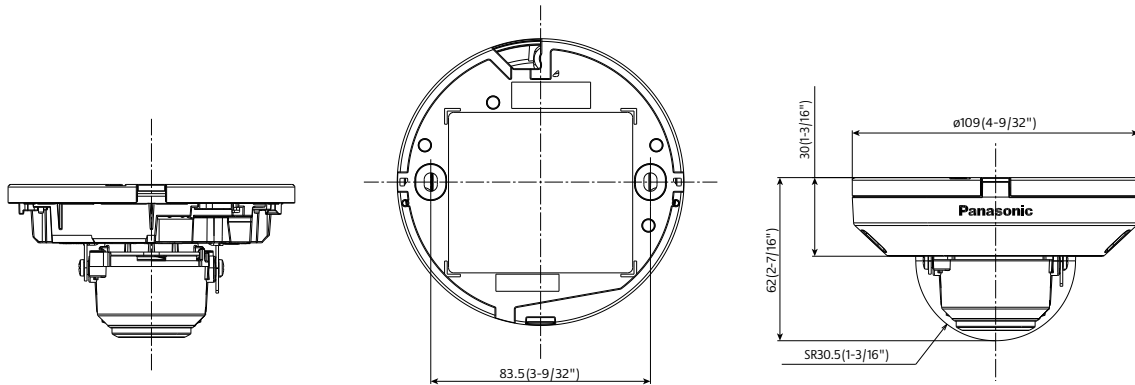





## Appearance

Unit : mm (inches)



## Optional Accessories

### Mount Bracket / Other

	WALL		POLE	CORNER	HANGING	CEILING
	1	2	1	1	1	1
combination	Wall Mount Bracket <b>WV-QWL500-W</b> (i-PRO white) 	Base bracket <b>WV-QJB502-W</b> (i-PRO white) 	Pole Mount Bracket <b>WV-QPL500-W</b> (i-PRO white) 	Corner Mount Bracket <b>WV-QCN500-W</b> (i-PRO white) 	Ceiling Mount Bracket <b>WV-QCL100-W</b> *1 (i-PRO white) 	Base bracket <b>WV-QJB502-W</b> (i-PRO white) 
	Adapter Box <b>WV-QJB500-W</b> (i-PRO white)  *If needed.	/	Wall Mount Bracket <b>WV-QWL500-W</b> (i-PRO white) (+ <b>WV-QJB500-W</b> )  + 	Wall Mount Bracket <b>WV-QWL500-W</b> (i-PRO white) (+ <b>WV-QJB500-W</b> )  + 	3rd Parties Pipe	/

\*1 : It's possible to be used on the camera side and ceiling side. If used on both side, 2pieces are required.

### Dome Cover

Dome Cover (Smoke type)  
**WV-QDC500S**



#### Trademarks and registered trademarks

- iPad and iPhone are trademarks of Apple Inc., registered in the U.S. and other countries.
- Android is a trademark of Google LLC.
- ONVIF is trademarks or registered trademarks of Onvif Inc.
- All other trademarks identified herein are the property of their respective owners.

#### Important

- Safety Precautions : Carefully read the Basic Information, Installation Guide and Operating Instructions before using this product.
- Panasonic i-PRO Sensing Solutions Co., Ltd. cannot be held responsible for the performance of the network and/or other manufacturers' products used on the network.

• Masses and dimensions are approximate. • Specifications are subject to change without notice.

# Panasonic®

Panasonic Corporation

Panasonic i-PRO Sensing Solutions Co., Ltd.

<https://ipro.panasonic.com>

<https://security.panasonic.com>

<https://www.linkedin.com/company/i-pro-sensing-solutions-co-ltd/>

(2A-292A)